

1. Verify the package contents.

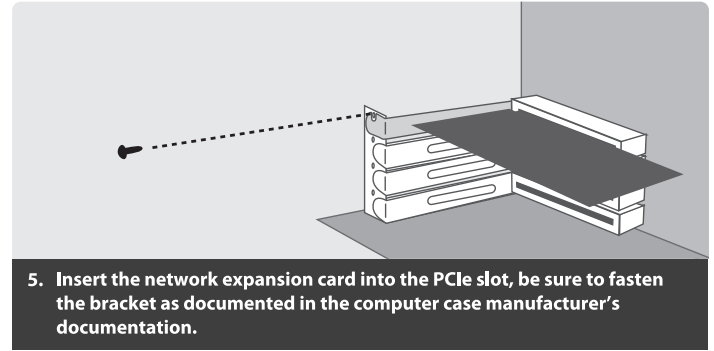

5. Insert the network expansion card into the PCIe slot, be sure to fasten the bracket as documented in the computer case manufacturer's documentation.

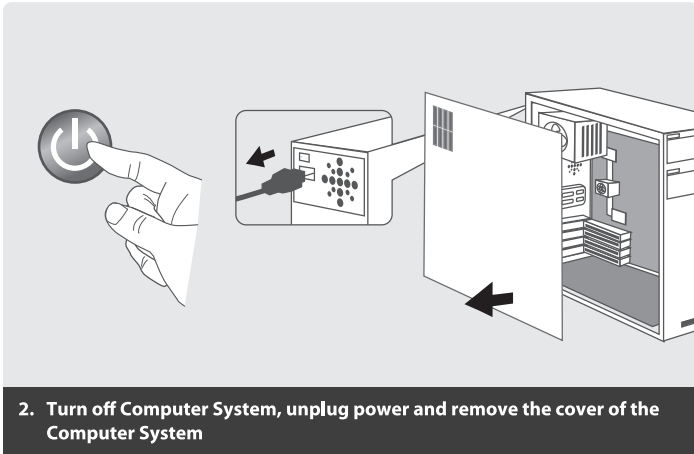

2. Turn off Computer System, unplug power and remove the cover of the Computer System

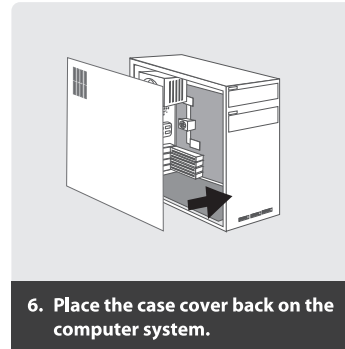

6. Place the case cover back on the computer system.

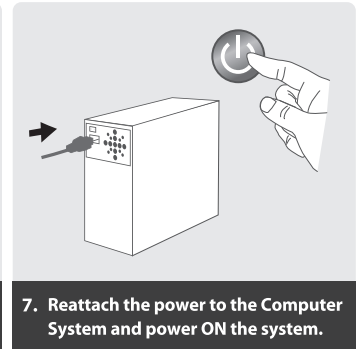

7. Reattach the power to the Computer System and power ON the system.

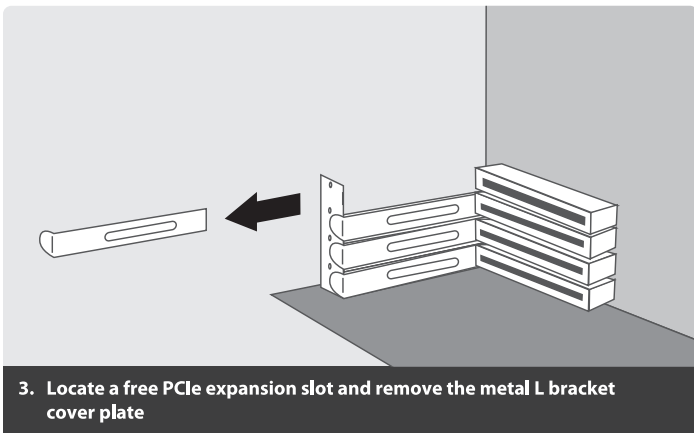

3. Locate a free PCIe expansion slot and remove the metal L bracket cover plate

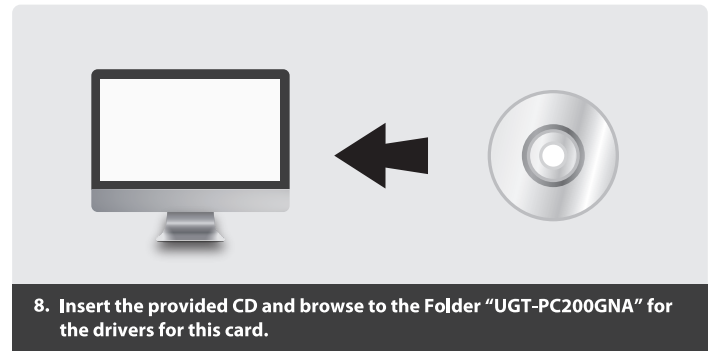

8. Insert the provided CD and browse to the Folder "UGT-PC200GNA" for the drivers for this card.

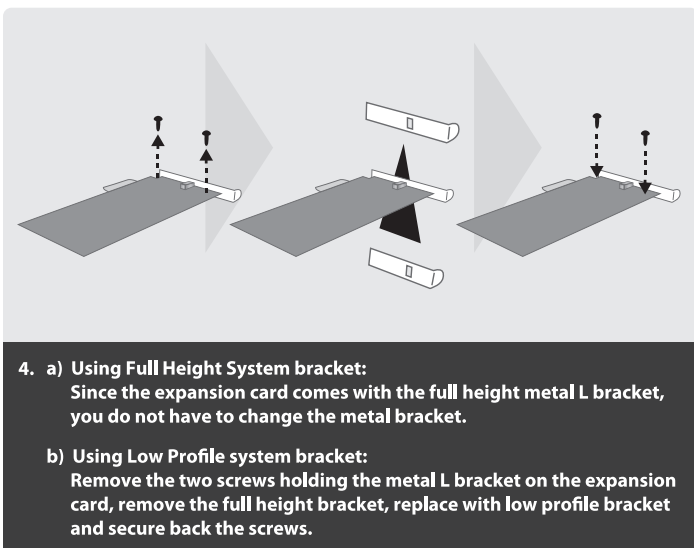

4. a) Using Full Height System bracket:
Since the expansion card comes with the full height metal L bracket, you do not have to change the metal bracket.
b) Using Low Profile system bracket:
Remove the two screws holding the metal L bracket on the expansion card, remove the full height bracket, replace with low profile bracket and secure back the screws.

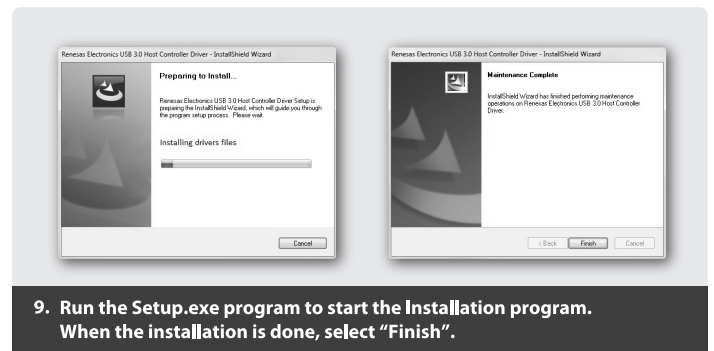

9. Run the Setup.exe program to start the Installation program. When the installation is done, select "Finish".

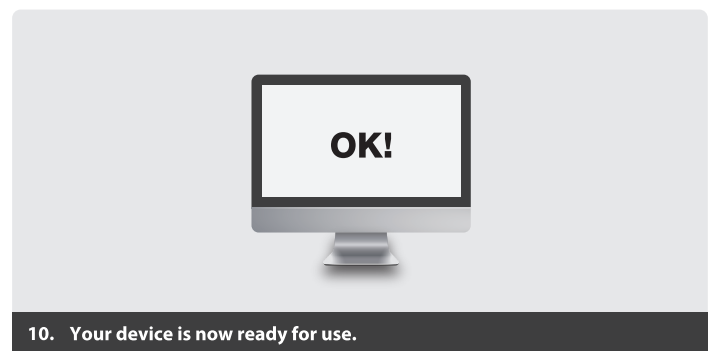

10. Your device is now ready for use.